

Connector AM-TOP® - Part no. 513

- screw terminals
- single part body
- cable gland and sealing
- strain relief and protection against kinking

Protection type	IP 44
Ampere	16 A
Poles	4p
Voltage	230
Hertz	50-60Hz
Earth position	9h
Contact	standard
Connection technology	Screw terminals

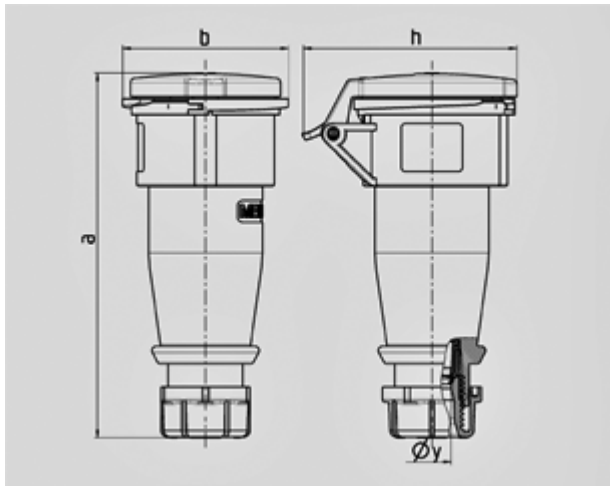

Drawing	Amp.	16			32		
		Poles			3	4	5
3 MB 63							
Dim. in mm	a	162	165	167	209	209	208
	b	60	68	76	82	82	89
	h	83	92	98	100	100	108
	y	14,5	16	16	22	22	22
Terminal for cond. cross		1	1	1	2,5	2,5	2,5
section (mm ²) min.-max.		-2,5	-2,5	-2,5	-6	-6	-6