

Wall mounted socket - Part no. 1267

- screw terminals
- external fixing
- cable entry at top

Protection type	IP 44
Ampere	16 A
Poles	4p
Voltage	230
Hertz	50-60Hz
Earth position	9h
Contact	standard
Connection technology	Screw terminals

Std. Pack. 10 Qty.

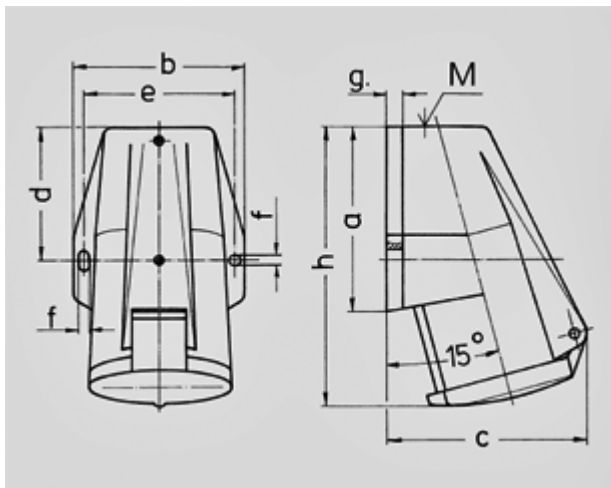

Drawing	Amp.	16			32		
		Poles			3	4	5
1 MB 205							
Dim. in mm	a	91	91	91	102	102	102
	b	73	79	87	89	89	94
	c	86	93	99	108	108	114
	d	55	55	56,4	62	62	62
	e	62	68	76	77,5	77,5	84
	f	5,3	5,3	5,3	5,3	5,3	5,3
	g.	8	8	9	10	10	10
	h	132	132	132	153	153	153
	M	20	25	25	25	25	32
	Max. cable diam. (mm)	13	18	18	18	18	25
	Terminal for cond. cross section (mm ²) min.-max.	1,5	1,5	1,5	2,5	2,5	2,5
		-4	-4	-4	-10	-10	-10